

Viking™ L / XL mobile lift

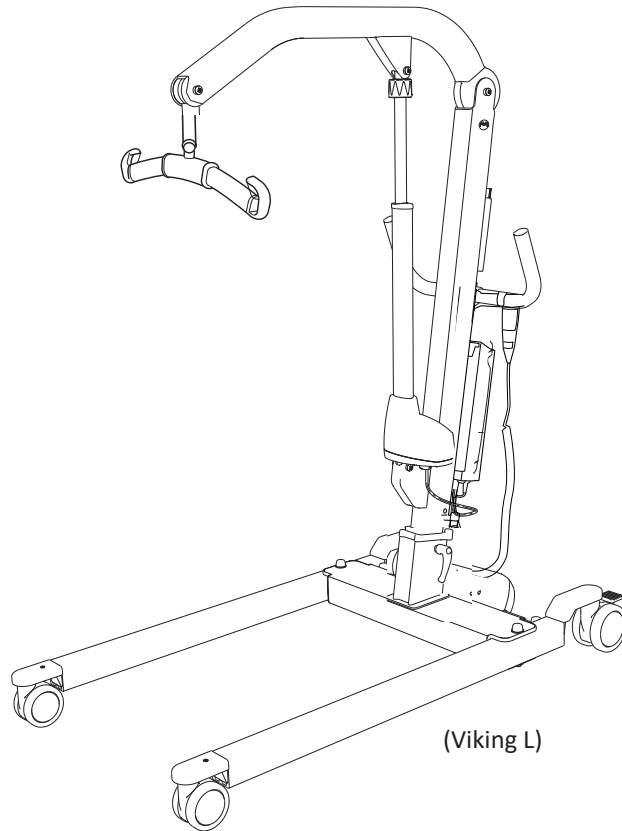

Instructions for Use

Viking L Prod. No. 2040044
Viking XL Prod. No. 2040043



Product Description

Viking™ L and XL mobile lifts are two versatile lift models intended mainly for use in health care, intensive care and rehabilitation. Viking L and XL mobile lifts are intended for heavier patients.

Both models are excellent aids in daily transfers of adults and bariatrics, for instance, lifting to and from wheel chair, bed, toilet and floor. A Viking™ mobile lift equipped with the Viking™ Armrest accessory can be used for gait training. Horizontal lifting can also be performed in combination with a recommended Liko™ stretcher accessory.

The control box together with the handcontrol contains a series of features which meet the needs for a safe and comfortable lift. Data is collected in the control box (work counter & intelligent cycle counter) and can be read out from the information display.

Individual fitting of Liko slings and other Liko lifting accessories to fit the patient is of the utmost importance for optimal performance and safety when using the lift.

In this document, the person being lifted is referred to as the patient, and the person helping them is referred to as the caregiver.

IMPORTANT!





















Lifting and transferring a patient always involves a certain level of risk. Read the instructions for use for both the patient lift and lifting accessories before use. It is important to completely understand the contents of the instructions for use. The equipment should only be used by trained personnel. Ensure that the lifting accessories are suitable for the lift used. Exercise care and caution during use. As a caregiver, you are always responsible for the patient's safety. You must be aware of the patient's ability to make it through the lifting situation. If something is unclear, contact the manufacturer or supplier.

Table of Contents

Symbol Description	3
Safety Instructions.....	4
Definitions	5
Technical Data	5
Dimensions.....	6
EMC Table.....	7
Assembly	9
Operation	11
Charging the Battery.....	14
Maximum Load.....	15
Recommended Lifting Accessories	15
Troubleshooting	17
Recycling Instructions.....	17
Cleaning and Disinfection.....	18
Inspection and Maintenance.....	20

Symbol Description

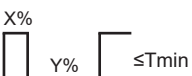
These symbols can be found in this document and/or on the product.

Symbol	Description
	For indoor use only.
	The product has extra protection against electric shock (Insulation Class II).
	Protection level against electric shock Type B.
	Warning; this situation requires extra care and attention
	Read instructions for use before use
	This product complies with EC directives.
IP N ₁ N ₂	Protection level against: ingress of solid objects (N1) and ingress of water (N2).
	Manufacturer
	Date of manufacture.
	Caution! consult instructions for use
	Consult instructions for use for more information
	Battery
	All batteries in this product must be recycled separately. - Pb underneath the symbol indicate batteries containing lead - Single Black line underneath the symbol indicate this product have been placed on the market after 2005.
	UL Recognized Component Mark for Canada and the United States
	EFUP, Environmental Friendly Usage Period (years)
	Environmentally-friendly product which can be recycled and reused.
	The Australian Safety/EMC
	PSE Mark (Japan)
	Product Identifier
	Serial Number
	Medical Device
	Recyclable
	The safety and essential performance of medical electrical equipment
	Proof of Product compliance to North American safety standards
	Non-ionizing electromagnetic radiation
	Duty cycle for non-continuous operation. The maximum active operation time X% of any given time unit, followed by a deactivation time, Y%. The active operation time shall not exceed the specified time in minutes, T.
	GS1 Data Matrix Barcode that may contain following information (01) Global Trade Item Number (11) Production Date (21) Serial Number

Safety Instructions

Intended use

This product is not intended to be used by the patient alone. Lifting and transferring a patient shall always be performed with the assistance of at least one caregiver. This product is used as a means to perform the lift but is not in contact with the patient; therefore we do not go into the various patient conditions in this manual. Contact your Hillrom representative for support and advice.

Certain environments and conditions can limit the correct use of the mobile lifts, including:

Thresholds, unlevel floor surfaces, various obstacles, and extra-thick carpets. These environments and conditions can cause the wheels of the mobile lift not to roll as intended, possible imbalance in the mobile lift, and increased exertion by the caregiver. If you are uncertain that your care environment fulfills the requirements for correct use of the mobile lift, please contact your Hillrom representative for further advice and assistance.

Unbalanced lifting poses a tipping risk and may damage the lift equipment!

Never leave a patient unattended during a lifting situation!

Do not raise the lift arm manually!

Before use, make sure that:

- the lift is assembled in accordance with the assembly instructions;
- the lifting accessory is properly attached to the lift;
- the battery has been charged for at least 6 hours;
- you have read the instructions for use for the lift and lifting accessories;
- personnel using the lift are informed of the correct operation and use of the lift.

Before lifting, always make sure that:

- the lifting accessories are not damaged;
- the lifting accessory is correctly attached to the lift;
- the lifting accessory hangs vertically and can move freely;
- the lifting accessory is selected appropriately, in terms of type, size, material and design, with regard to the patient's needs;
- the lifting accessory is correctly and safely applied to the patient in order to prevent injuries;
- the latches are intact; missing or damaged latches must always be replaced;
- the sling's strap loops are correctly connected to the sling bar hooks when the sling straps are stretched up but before the patient is lifted from the underlying surface.

Incorrect attachment of sling to slingbar may cause severe injury to the patient!



Prod. No. 2040043 and 2040044 are tested by an accredited testing institute.

No modification of the product is allowed.

Use of the product adjacent to other equipment should be avoided because it could result in improper operation, if such use is necessary, observe and verify that the other equipment is operating normally.

Electromagnetic disturbance, may affect the lifting performance of the product. Modification using other parts than original spare parts (cables etc.) may affect the electromagnetic compatibility of the product. Particular care must be observed when using strong sources of potential disturbance, such as diathermy, etc, so that diathermy cables are not positioned on or near the product.

If you have questions, please consult the responsible assistive device technician or the supplier.

The product may not be used in areas where flammable mixtures may occur, for example, in areas where flammable goods are stored.

This Caution notice is found on the Battery:

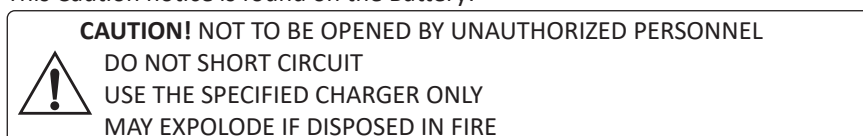

This Caution notice is found on the Control box:

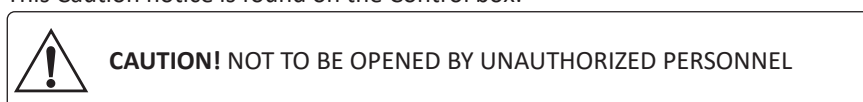

Definitions

1. Lift arm
2. Lift Mast (with color code for sling sizes)
3. Optional accessory:
Holder for Quick Reference Guide and color code for sling sizes.
4. Handles
5. Handcontrol
6. Battery
7. Control box with;
 - Emergency stop
 - Electrical Emergency Lowering
 - Electrical Emergency lifting
 - Battery charger indicators
 - Information display
8. Product decal
9. Locking handles
10. Motor for base-width adjustment
11. Rear wheels with brakes
12. Front wheels
13. Base
14. Lift Motor (Actuator)
15. Emergency Lowering Device (mechanical)
16. Sling Bar with latches
17. Flexlink

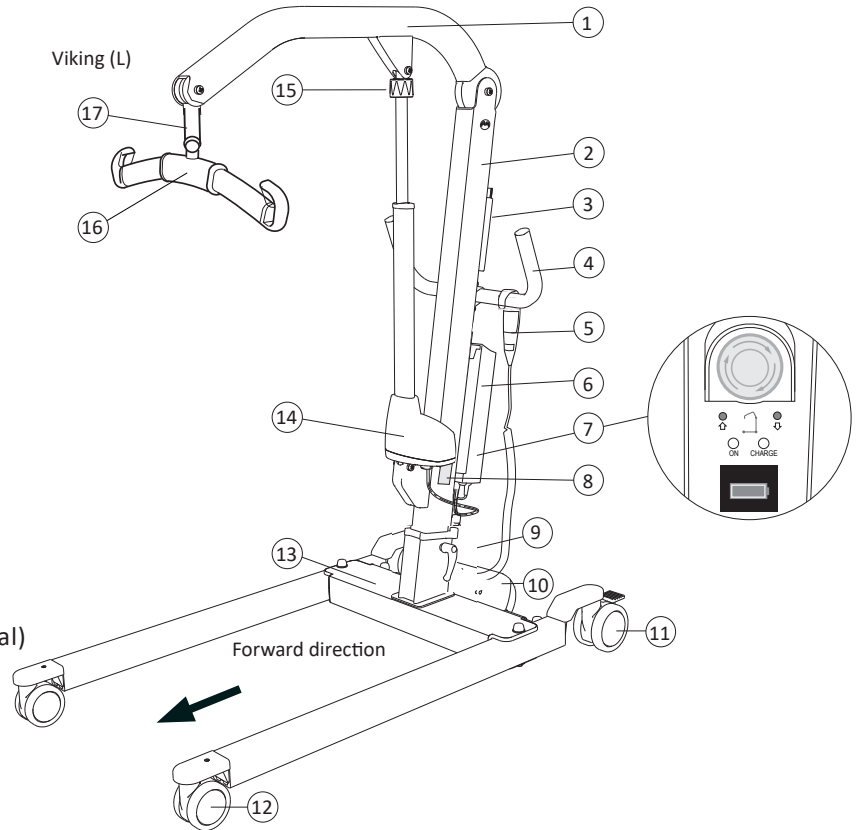

Technical Data

Maximum load:	Viking L: 250 kg (550 lbs) Viking XL: 300 kg (660 lbs)
Material:	Aluminium
Weight:	Viking L Total: 36,7 kg (81.0 lbs) Heaviest part: 21,6 kg (47.6 lbs) Viking XL Total: 39,9 kg (88.0 lbs) Heaviest part: 23,6 kg (52.0 lbs)
Wheels:	Viking L, XL Front: 100 mm (4 in) twin wheels. Rear: 125 mm (5 in) twin wheels.
Turning diameter:	Viking L: 1460 mm (57.4 in) Viking XL: 1570 mm (61.8 in)
Emergency lowering device:	Mechanical and electrical
Lifting interval:	Viking L: 1330 mm (52.4 in) Viking XL: 1370 mm (54.0 in)
Lifting speed (no load)	Viking L : 23 mm/s and 17 mm/s, Viking XL : 23 mm/s and 17 mm/s, (Viking L: 0.9 in/s and 0.7 in/s), (Viking XL: 0.9 in/s and 0.7 in/s).
Sound level:	Viking L : 51 dB(A) Viking XL : 51 dB(A)
Protection class:	IP X4
Operating Forces of Controls:	Handcontrol: 5 N
Electrical data:	24 V

Intermittent power:	Int. Op 10/90, active operation max 2 min. Only 10% of a given length of time may be active, but no more than 2 min.
Batteries:	Lead-acid gel, valve-regulated battery 24 V 2.9 Ah Prod. No. 2006106. Weight: 2,8 kg (6.2 lbs.) Li-ION battery 25.6 V, 3.3 Ah Prod. No. 2006110. Weight: 1,4 kg (3.1 lbs.)
Battery charger:	Internal charger, 100-240 V AC, 50-60 Hz, max. 400 mA.
Lift motor:	Permanent magnet motor with mechanical safety mechanism. Viking L: 24 V, 8.0 A Viking XL: 24 V, 9.0 A
Motor for base-width adjustment:	Permanent magnet motor 24 V, 5,5 A
Surrounding functional environment:	Temperature: +10°C to +40°C, (50° F to 104° F) Humidity: 20% to 80% at 30°C non-condensing, Air pressure: 700HPa to 1060HPa, Altitude: max. 3000m.



The device is intended for use indoors



Type B, in accordance with the electrical shock protection class.



Class II equipment.

Dimensions

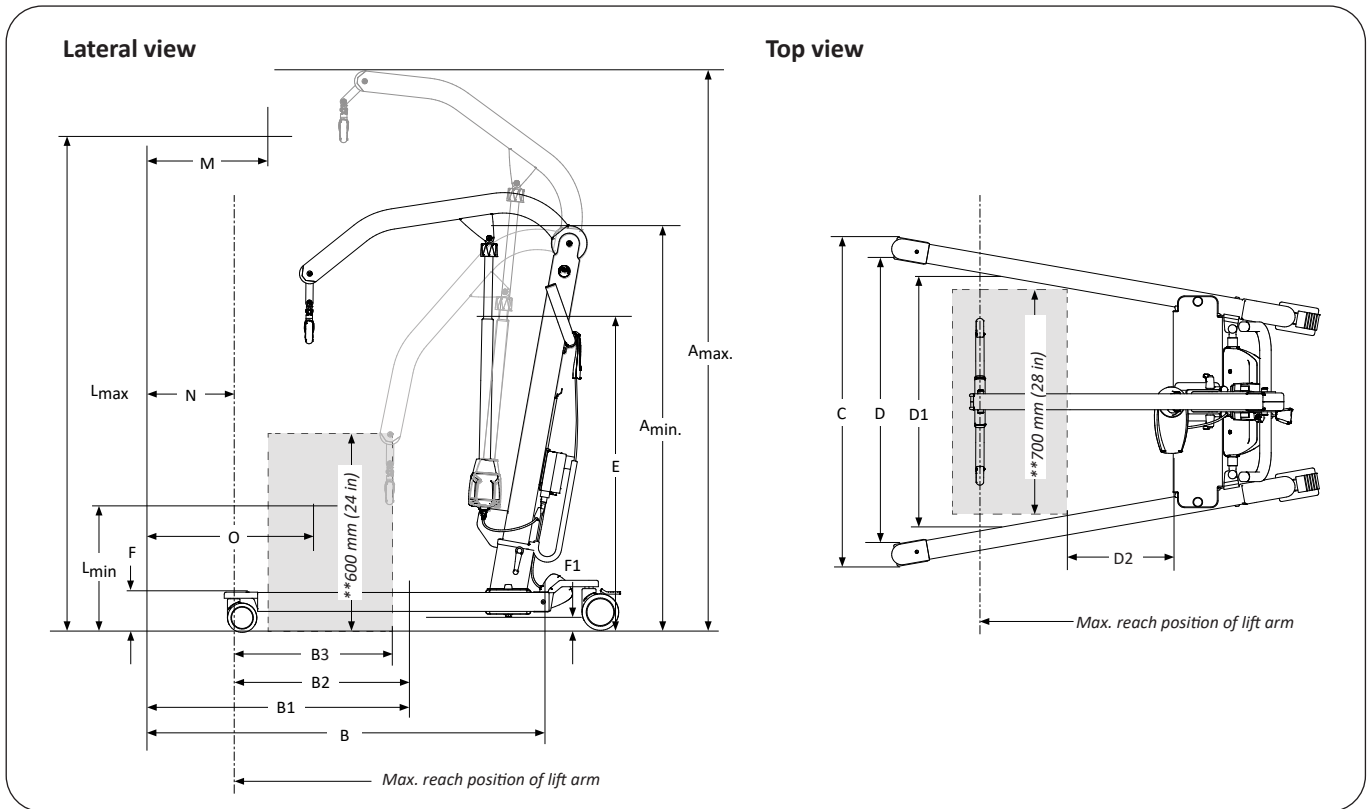

Viking L

Measurements: mm / in

A _{max}	A _{min}	B	B ₁	B ₂	B ₃ **	C		D		D ₂ **	E	F	F ₁	L _{max}	L _{min}	M	N	O
						max	min	max	min									
2030	1390	1360	900	630	560	1070	695	950	625	230	1060	140	43	1790	460	500	280	550
80.0	54.7	53.5	35.4	24.8	22.0	42.1	27.4	37.4	24.6	9.1	41.7	5.5	1.7	70.5	18.1	19.7	11.0	21.7

Viking XL

Measurements: mm / in

A _{max}	A _{min}	B	B ₁	B ₂	B ₃ **	C		D		D ₂ **	E	F	F ₁	L _{max}	L _{min}	M	N	O
						max.	min.	max.	min.									
2110	1500	1420	960	600	560	1130	815	1015	605	145	1010	140	40	1910	540	557	365	665
83.1	59.1	55.9	37.8	23.6	22.0	44.5	32.1	40.0	23.8	5.7	39.8	5.5	1.6	75.2	21.3	21.9	14.4	26.2

Note: The measurements are based on the lift being equipped with standard sling bar. When changing to other lifting accessories, check that the lift still achieves desired lifting height.

** Reference measurement according to Standard EN ISO 10535:2006.

EMC Table

Guidance and manufacturer's declaration – electromagnetic emissions

The mobile lift is intended for use in the electromagnetic environment specified below. The customer or the user of the mobile lift should assure that it is used in such an environment. The mobile lift shall not move unintentionally while being submitted to disturbances.

Emissions test	Compliance	Electromagnetic environment - guidance
RF emissions CISPR 11	Group 1	The mobile lift uses RF energy only for its internal function. Therefore, its RF emissions are very low and are not likely to cause any interference in nearby electronic equipment.
RF emissions CISPR 11	Class B	The mobile lift is suitable for use in all establishments including domestic establishments and those directly connected to the public low-voltage power supply network that supplies buildings used for domestic purposes.
Harmonic emissions IEC 61000-3-2	Complies	
Voltage fluctuations/ flicker emissions IEC 61000-3-3	Complies	

Guidance and manufacturer's declaration – electromagnetic immunity

The mobile lift is intended for use in the electromagnetic environment specified below. The customer or the user of the mobile lift should assure that it is used in such an environment. The mobile lift shall not move unintentionally while being submitted to disturbances.

Immunity test	IEC 60601 test level	Compliance level	Electromagnetic environment - guidance
Electrostatic discharge (ESD) IEC 61000-4-2	+/- 8 kV contact +/- 15 kV air	+/- 8 kV contact +/- 15 kV air	+/- 8 kV contact +/- 15 kV air Floors should be wood, concrete or ceramic tile. If floors are covered with synthetic material, the relative humidity should be at least 30 %.
Electrical fast transient / Burst IEC 61000-4-4	+/- 2 kV for power supply lines +/- 1 kV for input/output lines	+/- 2 kV for power supply lines +/- 1kV for input/output lines	Mains power quality should be that of a typical commercial or hospital environment.
Surge IEC 61000-4-5	+/- 1 kV differential mode +/- 2 kV common mode	+/- 1 kV differential mode n/a. for common mode	Mains power quality should be that of a typical commercial or hospital environment.
Voltage dips, short interruptions and voltage variations on power supply input lines IEC 61000-4-11	0 % UT for 0,5 cycle, at 0, 45, 90, 135, 180, 225, 270 and 315 degrees 0 % UT for 1 cycle, at 0 degrees 70 % UT for 25 cycles at 50 Hz and 30 cycles at 60 Hz, at 0 degrees 0 % UT for 250 cycles at 50 Hz and 300 cycles at 60 Hz.	0 % UT for 0,5 cycle, at 0, 45, 90, 135, 180, 225, 270 and 315 degrees 0 % UT for 1 cycle, at 0 degrees 70 % UT for 25 cycles at 50 Hz and 30 cycles at 60 Hz, at 0 degrees 0 % UT for 250 cycles at 50 Hz and 300 cycles at 60 Hz.	Mains power quality should be that of a typical commercial or hospital environment. If the user of the mobile lift requires continued operation during power mains interruptions, it is recommended that the mobile lift be powered from an uninterrupted power supply or battery.
Power frequency (50/60 Hz) magnetic field IEC 61000-4-8	30 A/m	Complies	Power frequency magnetic fields should be at levels characteristic of a typical location in a typical commercial or hospital environment

NOTE U_T is the a.c. mains voltage prior to application of the test level.

Guidance and manufacturer's declaration – electromagnetic immunity

The mobile lift is intended for use in the electromagnetic environment specified below. The customer or the user of the mobile lift should assure that it is used in such an environment. The mobile lift shall not move unintentionally while being submitted to disturbances.

Immunity test	IEC 60601 test level	Compliance level	Electromagnetic environment - guidance
Conducted RF IEC 61000-4-6	6 Vrms 150 kHz to 80 MHz	6 Vrms	<p>Portable and mobile RF communications equipment should be used no closer to any part of the mobile lift, including cables, than the recommended separation distance calculated from the equation applicable to the frequency of the transmitter.</p> <p>Recommended separation distance</p> $d = 1,2\sqrt{P}$ $d = 1,2\sqrt{P} \quad 80 \text{ MHz to } 800 \text{ MHz}$ $d = 2,3\sqrt{P} \quad 800 \text{ MHz to } 2,7 \text{ GHz}$ <p>where P is the maximum output power rating of the transmitter in watts (W) according to the transmitter manufacturer and d is the recommended separation distance in meters (m).</p> <p>Field strengths from fixed RF transmitters, as determined by an electromagnetic site survey,^a should be less than the compliance level in each frequency range.^b</p> <p>Interference may occur in the vicinity of equipment marked with the following symbol.</p> <div style="text-align: center;">  </div>
Radiated RF IEC 61000-4-3	10 V/m 80MHz to 2,7GHz	10 V/m	

NOTE 1 At 80MHz and 800MHz, the higher frequency range applies.

NOTE 2 These guidelines may not apply in all situations. Electromagnetic propagation is affected by absorption and reflected from structures, objects and people.

^a Field strengths from fixed transmitters, such as base stations for radio (cellular/cordless) telephones and land mobile radios, amateur radio, AM and FM radio broadcast and TV broadcast cannot be predicted theoretically with accuracy. To assess the electromagnetic environment due to fixed RF transmitters, an electromagnetic site survey should be considered. If the measured field strength in the location in which the mobile lift is used exceeds the applicable RF compliance level above, the mobile lift should be observed to verify normal operation. If abnormal performance is observed, additional measures may be necessary, such as reorienting or relocating the mobile lift.

^b Over the frequency range 150 kHz to 80 MHz, field strengths should be less than 10 V/m.

Recommended separation distances between portable and mobile RF communications equipment and the mobile lifts listed above

The mobile lift is intended for use in an electromagnetic environment in which radiated RF disturbances are controlled. The customer or the user of the mobile lift can help prevent electromagnetic interference by maintaining a minimum distance between portable and mobile RF communications equipment (transmitters) and the mobile lift as recommended below, according to the maximum output power of the communications equipment.

Rated maximum output power of transmitter (W)	Separation distance according to frequency of transmitter (m)		
	150 kHz to 80 MHz $d = 1,2\sqrt{P}$	80 MHz to 800 MHz $d = 1,2\sqrt{P}$	800 MHz to 2.7 GHz $d = 2,3\sqrt{P}$
0.01	0.12	0.12	0.24
0.1	0.38	0.38	0.73
1	1,2	1.2	2.3
10	3,8	3.8	7.3
100	12	12	23

For transmitters rated at a maximum output power not listed above, the recommended separation distance d in meters (m) can be estimated using the equation applicable to the frequency of the transmitter, where P is the maximum output power rating of the transmitter in watts (W) according to the transmitter manufacturer.

Note 1: At 80 MHz and 800 MHz, the separation distance for the higher frequency range applies.

Note 2: These guidelines may not apply in all situations. Electromagnetic propagation is affected by absorption and reflection from structures, objects and people.

For Radiated RF immunity test level:

$$E = \frac{6}{d} \sqrt{P}$$

Where P is the maximum power in W, d is the minimum separation distance in m, and E is the immunity test level in V/m. The factor of 6 is a compromise for a range of antenna factors, to simplify the test.

Assembly

Before assembly, make sure you have the following parts:

- Lift mast with lift arm, lift motor incl. cable, sling bar and control box with handcontrol
- Base with motor for base-width adjustment, incl. cable
- Locking handles, pair (2 pair Viking XL)
- Battery
- Instructions for use, charger cable, charger connector cable.

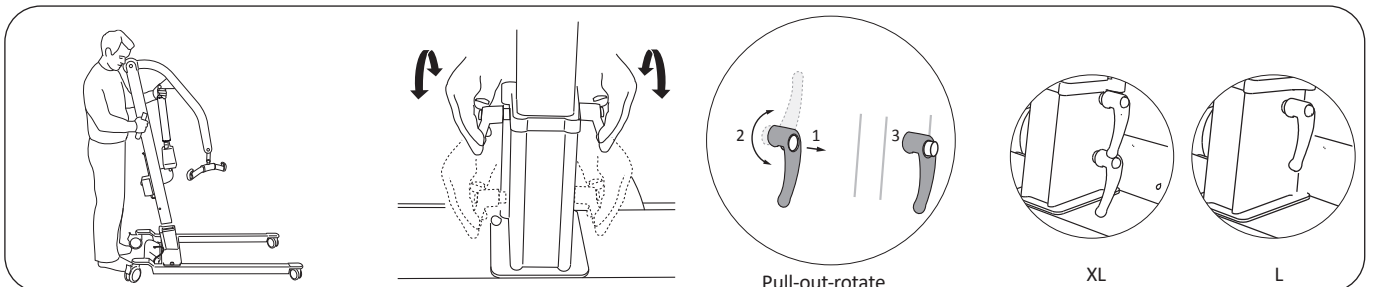

1. Lock both rear wheels.
Place the lift mast in the foot of the base.

2. Use the pair of locking handles to secure the lift mast in the base.
Note! (XL) 2 pair, start in the lower hole and use "Pull-out-rotate" to secure lift mast, see illustration.

3. After securing the mast use "Pull-out-rotate" to set the locking handles in a downwards position, see illustration.

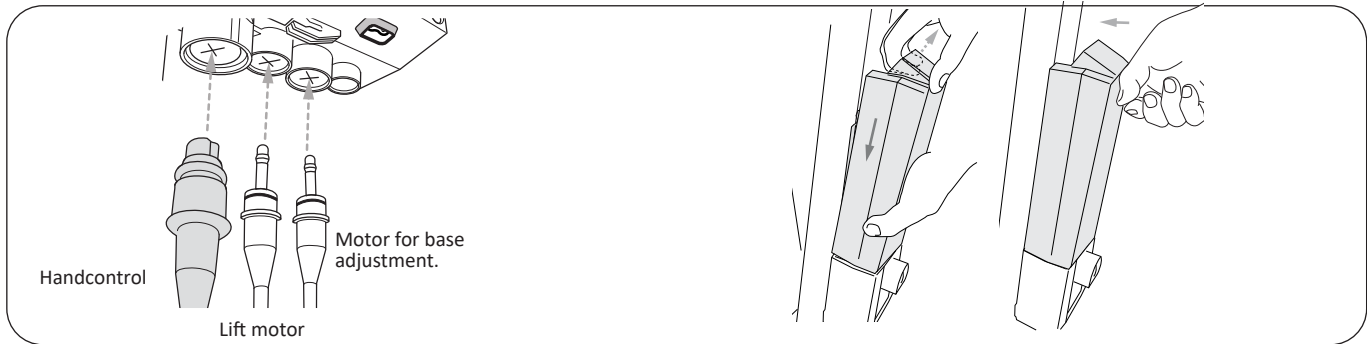

4. Connect cables to the control box, see illustration. Make sure plugs are fully seated.

5. Connect the battery and secure it to the control box bracket. A click sound can be heard when the battery is installed correctly.

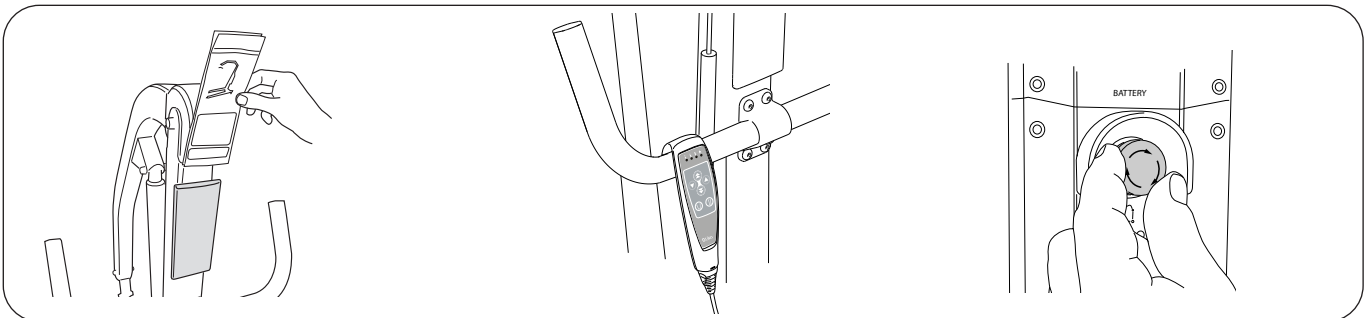

6. **Optional accessories:**
 - Quick reference guide
 - Holder for Quick reference guide.

7. Hang the handcontrol on the handle.

8. Reset the emergency stop by turning the button clockwise.

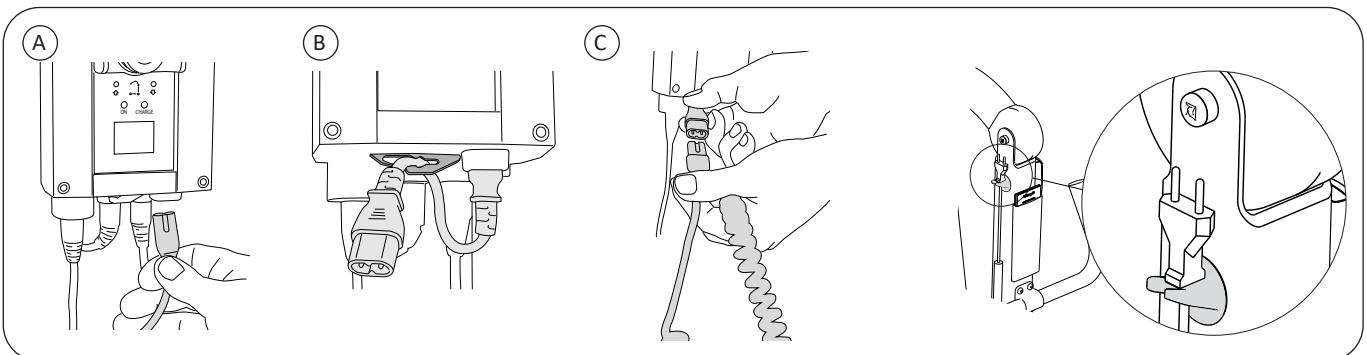

9. A) Connect the extension cable for the charging cable to the control box.
 B) Insert the extension cable in the tension clip underneath the control box.
 C) Connect the charging cable to the extension cable.

10. Place the charger cable on the hook provided on the mast after completed charging.

NOTE! Always charge the battery before using the lift the first time, See chapter "Charging the Battery".

After assembly and charging, ensure that:

- the battery has been fully charged
- lift arm motions correspond with the buttons on the handcontrol
- service interval is activated! Push following buttons on the handcontrol simultaneously:
 Up / Down , until a audio signal (single beep) is heard = service interval activated.
(Alternatively use the push buttons simultaneously for emergency lifting up and down on the control box)
- base width adjustment correspond with the buttons on the handcontrol
- emergency lowering works properly (mechanical and electrical)
- Rear wheel brakes, functions properly.

NOTE! The lifting height can be affected when lifting maximum load during in-run of actuator (up to 10 lifts).

Operation

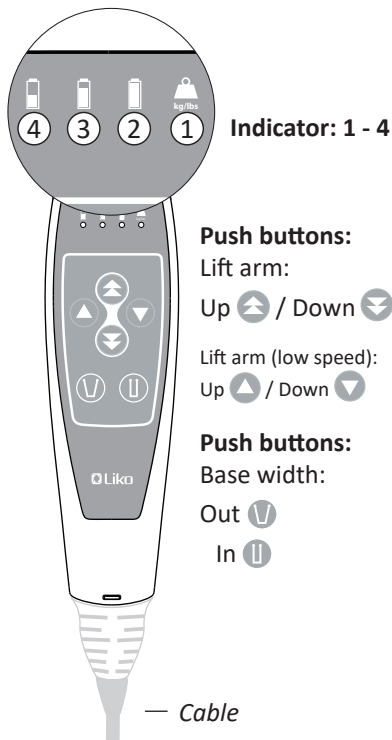

Handcontrol operation and indicators

Operate the lift using the push buttons on the handcontrol. For raising and lowering: Directional arrows show the direction of movement (up/down) The lifting and base movement stops as soon as the push button is released.

Indicator: 1 - 4

- 1 - Overload (Kg/lbs) light "flashes yellow", too much load is applied to the lift.
- 2 - Green light, battery power (100 - 50 %), Ok!
- will constantly light up green when charger is connected to mains.
- 3 - Yellow light, battery power (50 - 25 %), battery needs charging
- 4 - Yellow light, battery power (Less than 25 %), battery needs charging.
A buzzer will sound when pressing a push button.
Note! If the buzzer sound starts during an ongoing lift complete the lift and charge the lift afterwards!
- 4 - Light "flashes yellow" and a buzzer will sound when pressing a push button.
Charge the lift immediately! The remaining battery power can only make the lift arm go down.

Note! Please see chapter "Charging the Battery" for more information.

Control Box operation and information

1. Emergency Stop button
- Activate: Push the red button
- Reset: Turn the red button clockwise.
2. UP (Arrow), Electrical emergency lifting.
3. DOWN (Arrow), Electrical emergency lowering.

Operation of the push buttons 2 and 3 are done by pressing with a narrow object into the circle mark above each (Arrow). The Actuator movement stops as soon as the push button is released.

4. "ON" - lights up green when the charger is connected to mains.*
5. "CHARGE" - lights up yellow constantly during charging and will turn off when charging is completed.
6. Display Pop-up information:

 Battery power (100 - 50 %) Ok!

 Battery power (50 - 25 %) Battery needs charging.

 Battery power (Less than 25 %) battery needs charging.

A buzzer will sound when pressing a push button.

Note! If the buzzer sound starts during an ongoing lift complete the lift and charge the lift afterwards!

 Charge the lift immediately! A buzzer will sound when pressing a push button. The remaining battery power can only make the lift arm go down.

 The lift is connected to the mains.

 Short circuit warning!
check cables and connections.
Warning is shown until repaired!



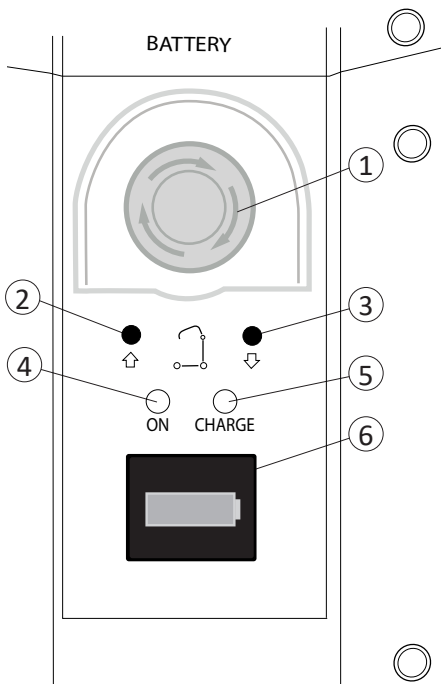

 Overload!
Too much load is applied to the lift.

 Service needed; contact Hillrom.



6. Information display:

Activate information display by a "quick press" at a UP, push button.

	xxxxx	→ Total number of lift cycles with load
	xxxxxx	→ Work done by actuator; Amp. x Sec.
	xxx	→ Number of overload indications
	xx/xxx	→ Days since last service/Days between services.

Li-ION battery - specific information

Sleep mode! the sleep mode will be activated in a Li-ION battery if not in use or charged in one week or more. The sleep mode switches off the battery and it's electronics to save power. The battery will stay in sleep mode until the battery is set back to operation mode again.

How to set the Li-ION battery back in operation mode; Charge the battery, when the "CHARGE" indicator, (5) is lit the battery has been set back in operation mode and ready for use. Note! We recommend to charge the battery until charging is completed, see "Charging the Battery" for more information and instructions.

Delay! a delay to indicators for current battery power at the control box and hand control occurs if the emergency stop function is activated and restored, see 1 above.

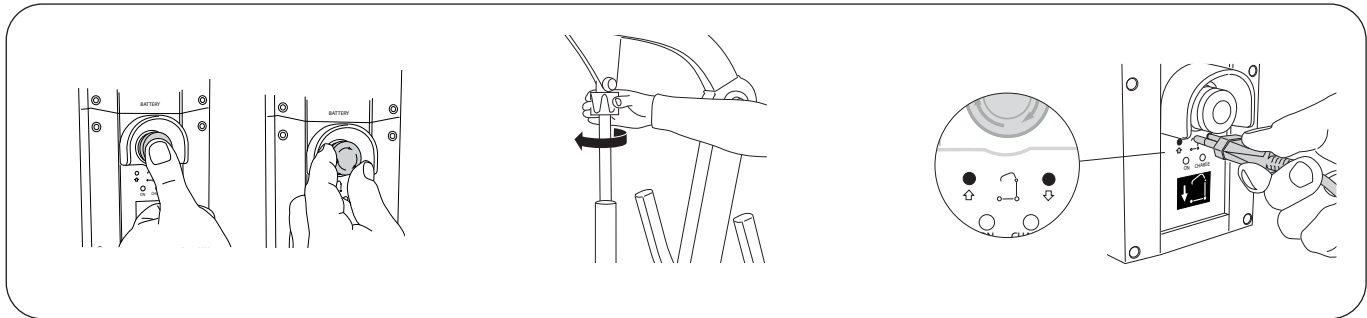

To activate the emergency stop:

Push the red Emergency Stop button on the control box.

To reset the emergency stop:

Turn the button clockwise.

Mechanical Emergency Lowering

Turn the emergency lowering control clockwise, repeat the movements until the patient being lifted is on a firm surface and the strap loops of the sling can be unhooked.

Electrical emergency lowering / lifting

Use a narrow object to press into the circle mark above each (Arrow), See chapter "Operation" for more information.

Do not use sharp objects, since this may cause damage on the control box!

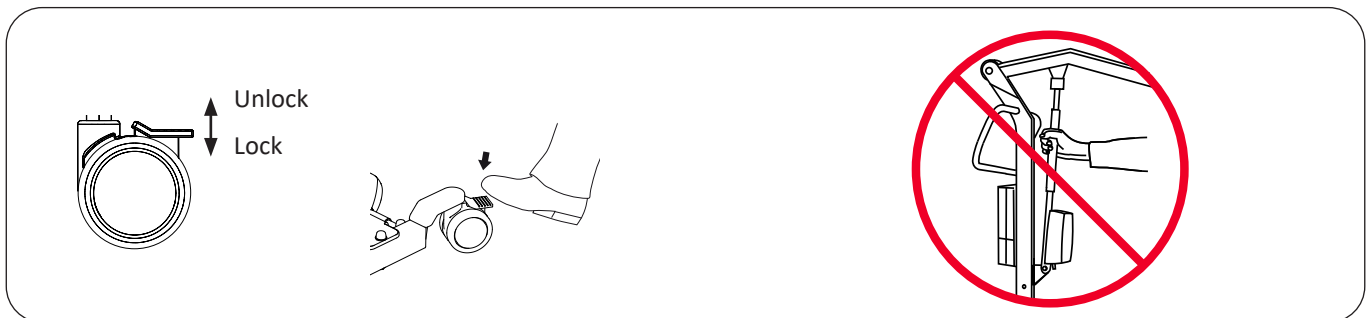

Locking the Wheels

The rear wheels can be locked to prevent rotating and turning. The locking/unlocking of the wheels is done with the foot.

NOTE: When lifting, the wheels should be unlocked so that the lift can be moved to the patient's centre of gravity. The wheels should be locked, however, if there is a risk of the lift rolling into the patient, for instance, when lifting from the floor.

⚠ Locked wheels during lifting can increase the risk of tipping.

⚠ Never move the lift by pulling on the actuator!

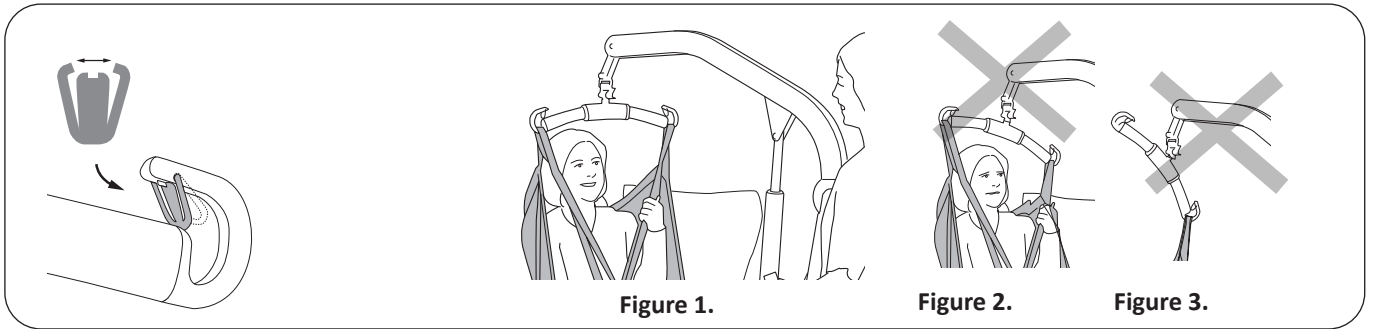

Figure 1.

Figure 2.

Figure 3.

Installation of Latches

After installation, ensure that the spring loaded latches is taut against the sling bar and moves freely in the sling bar hook.

Lift correctly!

Before each lift, make sure that:

- the Sling loops at opposite sides of the Sling are at the same height
- all the Sling loops are fastened securely in to the Slingbar hooks
- the Slingbar is level during the lift, see Figure 1.

⚠️ If Slingbar is not level (see Figure 2) or if the sling loops are wrongly attached to the slingbar (see Figure 3) lower the user to a firm surface and adjust according to the instructions for use of sling in use.

⚠️ An improper lift can be uncomfortable for the user and cause damage to the lift equipment! (see Figure 2 and figure 3).

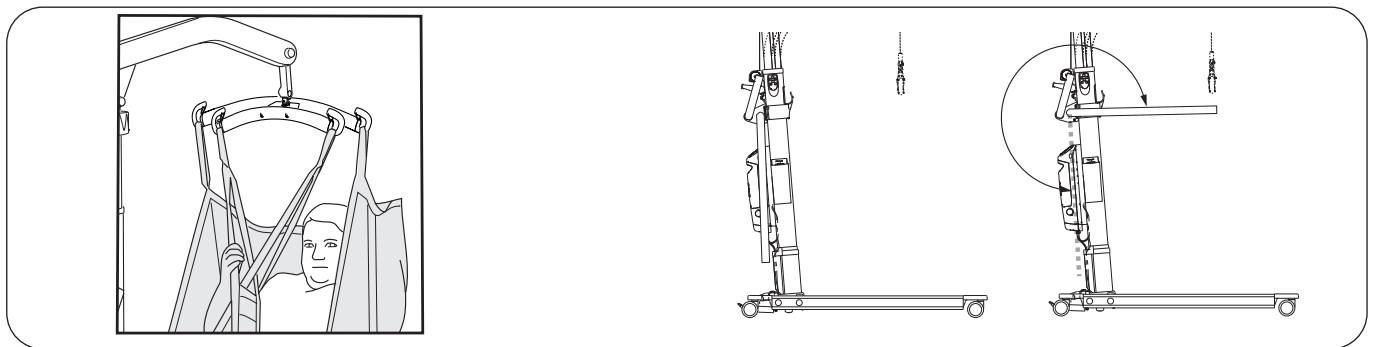

Using the Viking XL mobile lift with Twin bar

Universal TwinBar 670

Universal TwinBar 670 (prod. no. 3156077) for a maximum load of 300 kg (660 lbs) is included with Viking XL mobile lift. It is equipped with four hooks. The widest bar is intended for the upper strap loops of the sling and the short bar is for the strap loops of the leg supports. The wide sling bar provides for comfortable space for the upper body of the patient, even when the arms are on the inside of the sling.

⚠️ It is important that all four hooks be loaded when lifting.

Armrest

To use the armrest you need to rotate it from the (vertical) rest position up to the (horizontal) support position. The armrest have two purposes: to help the patient feel more secure and facilitate for the caregiver when moving the lift.

⚠️ When using the lift to transfer a patient between rooms, the armrest should be set in the support position!

Position of the Lift when Lifting

From/To:	Bed	Chair/Toilet Seat	Floor
			<p>NOTE: Place a pillow under the patient's head for increased performance and comfort. Always have the wheels locked when lifting from the floor.</p>

Charging the Battery

Charger information

1. "ON" - lights up green when the charger is connected to mains.
2. "CHARGE" - lights up yellow constantly during charging and will turn off when charging is completed.

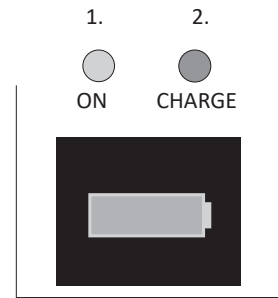

NOTE! Charging a deep discharged Li-ION battery

When charging a deep discharged Li-ION battery the charger will start charging at a low charging rate to protect the battery. During the low rate charging the charge indicator will not light up.

When the low rate charging is completed the charger will automatically switch to normal charge rate and the "CHARGE" indicator will light up yellow and will turn off when charging is completed.

Charging with the control box internal charger (standard)

Plug the charger cable into mains (100-240 VAC), see charger information 1 - 2 above. The battery is fully charged after about 6 hours and the charger disconnects automatically, the yellow "CHARGE" indicator turns off.

For maximum battery life, batteries must be charged regularly.

We recommend charging after each use or every night.

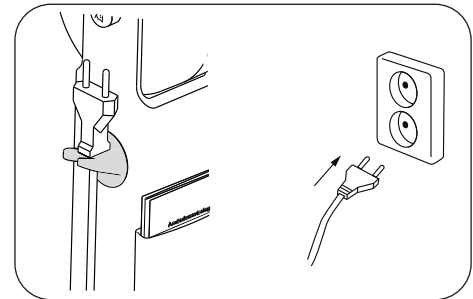

Never charge batteries in a wet area!

NOTE! If the charger cable is stretched out it should be replaced to avoid the risk of the cable getting caught and tear.

NOTE! The lift cannot be used when the charger cable is plugged into a wall socket.

NOTE! If the yellow "CHARGE" indicator at the control box continues to be lit after 8 hours, discontinue charging and replace the battery with a new one.

NOTE! A damaged battery shall be replaced and contact with leaking fluids shall be avoided.

Alternative charging procedures

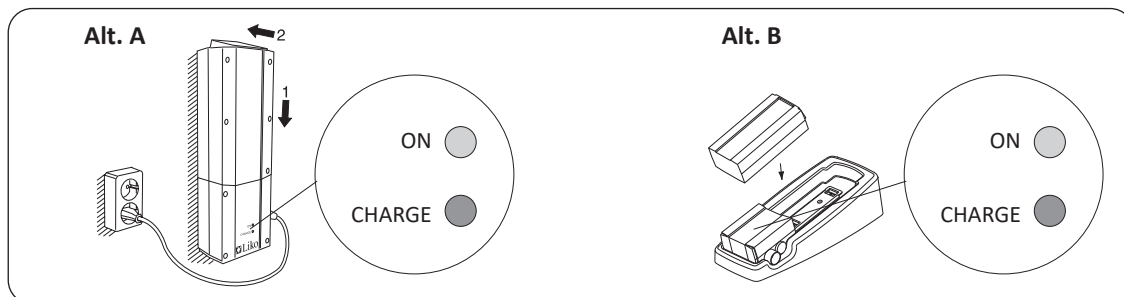

Wall mounted charger accessory or table charger housing accessory:

Loosen the holder for the charger cable. Remove the battery pack from the control box by loosening the locking device on top of the battery pack. See chapter "Assembly".

Charger information;

"ON" - lights up green when the charger is connected to mains.

"CHARGE" - lights up yellow constantly during charging and will turn off when charging is completed.

Alt. A. Place the battery pack on the wall mounted charger. Plug the charger cable into mains (100-240 VAC) check that both "ON" and "CHARGE" on the charger lights up.

Alt. B. Place the battery pack on the charger in the table charger housing. Plug the charger cable into mains (100-240 VAC) check that both "ON" and "CHARGE" on the charger lights up.

Maximum Load

Different maximum loads may apply to different products on the assembled lift unit, sling bar, sling and any other accessories used. For the assembled lift unit, the maximum load is always the lowest maximum load rating for any of the components. For example, a Viking™ L mobile lift which is approved for 250 kg (550 lbs) can be equipped with a lifting accessory which is approved for 200 kg (440 lbs). In this case, the maximum load of 200 kg (440 lbs) applies to the assembled lift unit.

Study the markings on the lift and lifting accessories or contact your Hillrom representative if you have any questions.

Recommended Lifting Accessories



⚠ Using lifting accessories other than those approved can entail a risk.

Recommended sling bars and accessories for Viking™ L and XL mobile lifts are listed below.

When changing sling bar or other lifting accessories, the highest possible lifting height of the lift is affected. Before changing lifting accessories you should always ensure that the lift, after change, can fulfil the desired lifting height in order to manage the lifting situations for which the lift is to be used. For additional guidance in selecting a sling, study the instructions for use for the respective sling models. There you will also find guidance for combining Liko™ sling bars with Liko slings.

Contact your Hillrom representative for advice and information on Liko's product range.

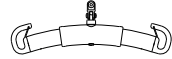
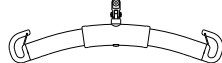
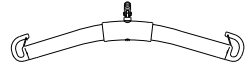
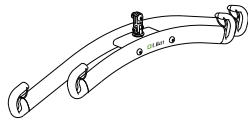
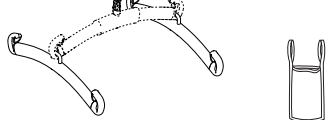
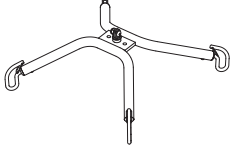
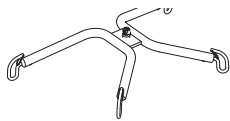
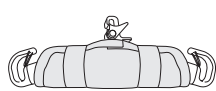
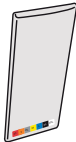
*** this product is also available in a version with Quick-Release Hook.**

<p>Universal SlingBar 350* Max. 300 kg (660 lbs)</p>	<p>Prod. No. 3156074</p>	
<p>Universal SlingBar 450* (Standard on Viking™ L mobile lift) Max. 300 kg (660 lbs)</p>	<p>Prod. No. 3156075</p>	
<p>Universal SlingBar 600* Max. 300 kg (660 lbs)</p>	<p>Prod. No. 3156076</p>	
<p>Universal TwinBar 670* (Standard on Viking™ XL mobile lift) Max. 300 kg (660 lbs)</p>	<p>Prod. No. 3156077</p>	
<p>Universal SideBars 450 including bag Max. 300 kg (660 lbs)</p>	<p>Prod. No. 3156079</p>	
<p>Sling Cross-bar 450* Max. 300 kg (660 lbs)</p>	<p>Prod. No. 3156021</p>	
<p>Sling Cross-bar 670* Max. 300 kg (660 lbs)</p>	<p>Prod. No. 3156018</p>	
<p>SlingBar Cover Paddy 30 (fits Universal SlingBars 350, 450, and 600)</p>	<p>Prod. No. 3607001</p>	
<p>Holder for Quick Reference Guide</p>	<p>Prod. No. 2000100</p>	
<p>Quick Guide Liko Mobile lift system</p>	<p>Prod. No. 2000400</p>	

Quick-Release Hook

Liko™ Quick-Release Hooks is a system for quick change of lifting accessories on Liko’s mobile and stationary lifts. Viking™ mobile lift must be equipped with the Q-link 13 in order to be used with the Quick-release Hook.

The Quick-release Hook Universal fits the Universal SlingBar 350, 450 and 600 (prod. no. 3156074 - 3156076). Quick-release Hook TDM fits the SlingBar Mini 220 (prod. no. 3156005), Sling Cross-bar 450 and 670 (prod. no. 3156021 and 3156018) and Universal TwinBar 670 (prod. no. 3156077).

When changing to a sling bar with quick release hook, the lifting height is reduced by 33 mm (1.3 in) in comparison with a fixed sling bar.

Contact Hillrom for further information.

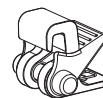

Quick-release Hook Universal
Prod. No. 3156508

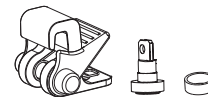

Quick-release Hook TDM
Prod. No. 3156502



Q-link 13
Prod. No. 3156509

Viking™ L and XL mobile lifts can be used for horizontal lifting with:

- Liko™ FlexoStretch** Prod .No. 3156057
- Liko™ OctoStretch** with Leveller Prod. No. 3156056
- Liko™ Stretch Mod IC, wide** Prod. No. 3156065B

Contact Hillrom for further information.



Bag for SlingBars Prod. No. 2001025

LikoScale™ device

for Weighing a patient in combination with Viking™ mobile lifts.

Adapter 12 mm is required.

LikoScale™ 350, Max 350 kg (770 lbs) Prod. No. 3156228

LikoScale™ 350 is certified according to the European Directive NAWI 2014/31/EU (Non-Automatic Weighing Instruments).

LikoScale™ devices only for use in the United states and Canada:

LikoScale™ 200, Max. 200 kg (440 lbs.) Prod. No. 3156225

LikoScale™ 400, Max. 400 kg (880 lbs.) Prod. No. 3156226.

Contact your Hillrom representative for more information.

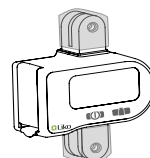

LikoScale™ device



Adapter 12 mm
Prod. No. 2016504

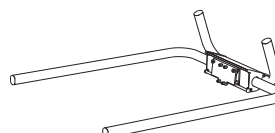

Viking Armrest Prod. No. 2047011

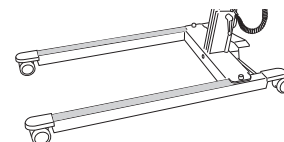

Leg Protector Viking L Prod. No. 2046012
Leg Protector Viking XL Prod. No. 2046013

Battery charger,

for wallmounting or to use with the Table charger housing

Prod. No. 2004106

Table charger housing

excl. charger and battery

Prod. No. 2107103

Battery

Lead battery (Pb)
Prod. No. 2006106

Battery

Li-ION battery
Prod. No. 2006110

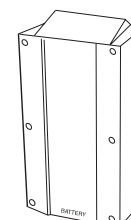
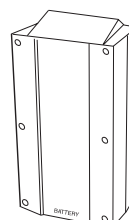
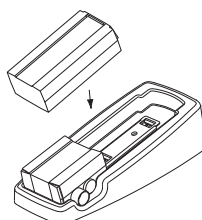
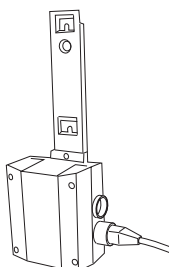

Troubleshooting

The lift do not work up/down with Hand Control.

The base-width adjustment doesn't work (in/out) with the Hand Control.



1. Make sure that the emergency stop button has not been activated (shall not be pressed in).
2. Check the battery capacity.
Check if the Li-ION battery has been set in to sleep mode, see chapter "Operation".
3. Make sure that the battery is properly seated in the control box.
4. Check that the charger cable is not connected to an electric outlet.
5. Check that the handcontrol cable is correctly connected to the control box.
6. Check that the lift arm actuator cable is correctly connected to the control box.
7. Check that the base width actuator cable is correctly connected to the control box.
8. *If the problem persists, please contact Hillrom.*

The charger doesn't work.



1. Check that the charger cables are connected correctly.
2. Make sure that the battery is properly seated in the control box.
3. Try an alternative mains outlet.
4. *If the problem persists, please contact Hillrom.*

The lift is stuck in the high position.



1. Make sure that the emergency stop button has not been activated (shall not be pressed in).
2. Make sure that the battery is properly seated in the control box.
3. Check the battery capacity.
Check if the Li-ION battery has been set in to sleep mode, see chapter "Operation".
4. Check that the handcontrol cable is connected correctly.
5. Electrical emergency lowering, use the operation panel to lower the patient onto a firm surface, see chapter; Operation.
6. Use the mechanical emergency lowering device to lower the patient onto a firm surface, see chapter; Operation.
7. *If the problem persists, please contact Hillrom.*

If you hear unusual sound from the lift.



Contact Hillrom.

Recycling instructions



Lead battery (Pb) or Li-ION battery



Waste of Electrical and Electronic Equipment (WEEE).



Metals



Old batteries are to be deposited at the nearest recycling station or given to personnel authorized by Hillrom.

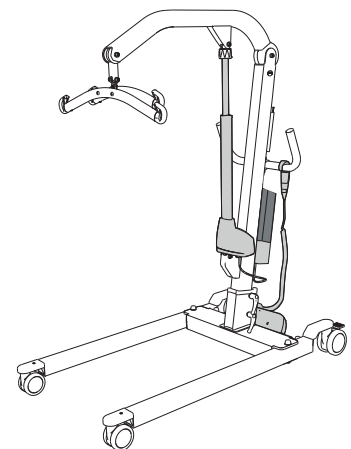

Hillrom evaluates and provides guidance to its users on the safe handling and disposal of its devices to aid in the prevention of injury, including, but not limited to: cuts, punctures of the skin, abrasions, and any required cleaning and disinfection of the medical device after use and prior to its disposal.

Customers should adhere to all federal, state, regional, and/or local laws and regulations as it pertains to the safe disposal of medical devices and accessories.

If in doubt, the user of the device shall first contact Hillrom Technical Support for guidance on safe disposal protocols.

Cleaning and Disinfection

Safety recommendations

Cleaning and disinfecting procedures for Liko™ Mobile lifts. This instructions do not replace the facility's own cleaning and disinfection policies.

- Wear protective equipment according to manufacturer's instruction and per facility protocol throughout the cleaning operations, such as: rubber gloves, goggles, apron, face mask and shoe covers.
- Unplug mains (AC power source) before cleaning and disinfection.
- Never clean the lift by pouring water on it, steam cleaning it, or by using a high-pressure jet.
- Refer to the recommendations made by the cleaning and disinfecting product manufacturer.

Equipment:

- Protective equipment (such as: rubber gloves, goggles, apron, face mask and shoe covers) as recommended by the facility protocol and manufacturers instructions
- Clean buckets
- Cloths for washing and drying
- Soft brush
- Warm water
- To find Cleaning / Disinfectants compatible or not compatible for use on Liko's products, follow the "Application of commonly used Cleaning / Disinfectants on Liko products" in this document.

Cleaning instructions

1. ⚠️ **Unplug mains (AC power source) before cleaning and disinfection.**
2. Clean the lift with a cloth moistened with warm water and a neutral cleaning agent approved by your organization. A soft brush may be used to remove stains and resistant dirt.
3. Wipe off the entire lift with a cloth moistened with clean water starting from the top and working down. The cloth shall not be so damp that it drips. To have access to all areas run the lift into the highest and lowest positions and extend the base width adjustment entirely in and out. Remove the Battery to have access behind the battery.

NOTE! Do not clean the piston rod!

4. Pay special attention to the following areas:
 - Sling bar
 - Mechanical emergency lowering
 - Handles
 - Control box
 - Battery
 - Hand control
 - Emergency stop
 - Operation panel/display (where applicable)
 - Lever for base width adjustment (where applicable)
 - Pedal for base width adjustment (where applicable)
 - Locking handles
 - Wheels

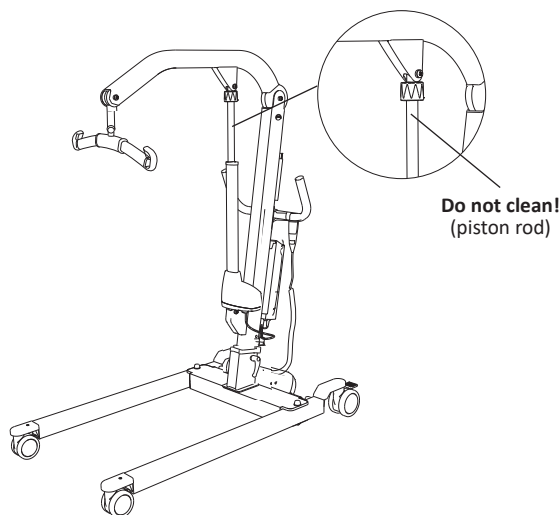

Disinfection Instructions

1. For the use of suitable disinfectants see "Application of commonly used Cleaning / Disinfectants on Liko products" in this document.
2. Use the choice of disinfectant according to the manufacturer's instructions and repeat the work step as in "Cleaning instructions"
3. Remove traces of disinfectant after disinfection. Wipe off the lift with a cloth moistened with clean water starting from the top and working down. The cloth shall not be so damp that it drips.

- ⚠️ **The lift may not be cleaned with CSI or equivalent.**
- ⚠️ **The hand control may not be cleaned with Viraguard or equivalent.**
- ⚠️ **The control box may not be cleaned with Anioxy Spray or equivalent.**

Application of commonly used Cleaning / Disinfectants on Liko products

Chemical class	Active ingredient	pH	Cleaners / Disinfectant *)	Manufacturer *)	May not be used on the following items:
Quaternary ammonium chloride	Didecyl dimethyl ammonium chloride = 8.704% Alkyl dimethyl benzyl ammonium chloride = 8.19%	9.0 – 10.0 in use	Virex II (256)	Johnson/Diversey	Foot rest for Sabina™ and Roll-On™
Quaternary ammonium chloride	Alkyl dimethyl benzyl ammonium chloride = 13.238% Alkyl dimethyl ethylbenzyl ammonium chloride = 13.238%	9.5 in use	HB Quat 25L	3M	
Accelerated Hydrogen Peroxide	Hydrogen Peroxide 0.1 -1.5% BenzylAlcohol: 1-5% Hydrogen Peroxide 0.1 -1.5% BenzylAlcohol: 1-5%	3	Oxivir Tb	Johnson/Diversey	The lift straps for Golvo™ and ceiling lifts
Phenolic	Ortho-Phenylphenol = 3.40% Ortho-Benzyl-para-Chlorophenol = 3.03	3.1 +/- 0.4 in use	Wexcide	Wexford Labs	
Bleach	Sodium hypochlorite	12.2	Dispatch	Caltech	The lift straps for Golvo™ and ceiling lifts
Alcohol	Isopropyl alcohol = 70%	5.0 – 7.0	Viraguard	Veridien	Hand controls for all lifts
Quaternary ammonium	n-Alkyl dimethyl benzyl ammonium chlorides = 0.105% n-Alkyl dimethyl ethylbenzyl ammonium chlorides = 0.105%	11.5 - 12.5	CSI	Central Solutions Inc.	Viking™, Liko M220™, Liko M230™, Uno™, Sabina™, Golvo™, LikoLight™, Roll-On™, Likorall™, Multirall™
Benzyl-C12-18-alkyldimethylammonium, chlorides	Benzyl-C12-18-alkyldimethylammonium, chlorides (22 %) 2-Phenoxyethanol (20 %) Tridecyl/polyethylenglycoether (15 %) Propan-2-ol (8 %)	approx 8.6 in use	Terralin Protect	Shülke	Foot rest for Sabina™ and Roll-On™
Organic peroxide (type E, solid)	Magnesium monoperoxyphthalate hexahydrate (50-100%) Anionic surfactant (5-10%) Nonionic surfactant (1-5%)	5.3 in use	Dismozon Pur	Bode	The lift straps for Golvo™ and ceiling lifts
Ethanol	Hydrogen peroxide (2.5-10 %) Lauryldimethylamine oxid (0-2.5 %) Ethanol (2.5-10 %)	7	Anioxy-Spray WS	Anios	Control box for all mobile lifts
Troscosene sodium	Adipic acid 10-30% Amorphous silica < 1% Sodium Toluene sulphionate 5-10 % Troscosene sodium 10-30 %	4-6 in use	Chlor-Clean	Guest Medical Ltd	The lift straps for Golvo™ and ceiling lifts

*) Or equivalent

Inspection and Maintenance

For trouble-free use, certain details should be checked each day the lift is used:

- Inspect the lift and check to make sure that there is no external damage.
- Check the sling bar attachment.
- Check the functionality of the latches.
- Check the integrity of the lifting motion and the base-width adjustment.
- Check to make sure that the emergency lowering (both electrical and mechanical) works.
- Charge the batteries each day the lift is used and then check that the charger works.

When necessary, clean the lift with a moist cloth and check that the wheels are free from dirt. Find more detailed information regarding cleaning and disinfection of your Liko product in chapter; *Cleaning and Disinfection*.

 The lift should not be exposed to running water.

Service

A periodic inspection of the lift should be carried out at least once per year.

 Periodic inspection, repair and maintenance should be performed only in accordance with the Liko™ Service Manual, and by personnel authorized by Hillrom and using original Liko™ spare parts.

Service Agreement

Hillrom offers the opportunity to enter into service contracts for the maintenance and regular inspection of your Liko product.

Expected Life Time

The product has an expected service life of 10 years when correctly handled, serviced and periodically inspected in accordance with Liko's instructions.

Parts listed below are subject to wear and tear and have specific expected life time:

- Handcontrol, expected life time 2 years,
- Battery, expected life time 3 years.

Transport and Storage

During transport, or if the lift is not to be used for a long time, the Emergency Stop should be activated.

The environment where the lift is transported and stored should have a temperature of -10°C to +50°C (14°F to 122°F), 20-90% humid., Pressure 700-1060 hPa.

The environment where batteries is transported and stored should have a temperature of -10°C to +40°C (14°F to 104°F), 20-80% humid., Pressure 700-1060 hPa.

Notice to Users and/or Patients in EU

Any serious incident that has occurred in relation to the device, should be reported to the manufacturer and the competent authority of the Member State in which the user and/or patient is established.

Product Changes

Liko products undergo continuous development. We reserve the right to make product changes without prior notice. Contact your Hillrom representative for advice and information about product upgrades.

Design and Quality by Liko in Sweden

The management system for both manufacturing and development of the product is certified in accordance with ISO9001 and its equivalent for the medical device industry, ISO13485. The management system is also certified in accordance with the environmental standard ISO14001.



 Liko AB
Nedre vägen 100
975 92 Luleå, Sweden
+46 (0)920 474700

Liko AB is a subsidiary of Hill-Rom Holdings, Inc.

www.hillrom.com

Enhancing outcomes for
patients and their caregivers:

