



METRO WHEELCHAIR

Metro - Attendant Propelled | Metro - Self Propelled | MetroX - Self Propelled

USER MANUAL



TABLE OF CONTENTS

1. Intended Use _____	4
2. Product Description _____	5
3. Warnings _____	5
4. Product Specifications _____	6
5. List of Components _____	7
6. Assembly _____	8
7. Preliminary Checks _____	9
8. General Operation _____	9
9. Troubleshooting _____	12
10. Care & Maintenance _____	13
11. Warranty _____	14
12. Compliance _____	15
13. Service Maintenance & Customisation _____	15
14. Service Log Book _____	16

Congratulations and thank you for choosing an Aspire Metro Wheelchair.

This product has been designed to offer the maximum in comfort, safety and compact portability. Aspire Metro Wheelchairs are suitable for indoor and outdoor use.

It is important that you read this user manual carefully before using your new wheelchair.

SYMBOLS USED IN THIS MANUAL

The symbols below are used throughout this user manual and on the product to identify warnings and important information. It is very important for you to read them and understand them completely.



Indicates a potentially hazardous condition/situation. Failure to follow designated procedures can cause either personal injury, component damage or malfunction. On the product, this icon is represented as a black symbol on a white triangle with a black border.



ALWAYS! These actions should be performed as specified. Failure to perform mandatory actions can cause personal injury and/or equipment damage. On the product, this icon is represented as a white infinity symbol on a black dot with a white border.



DO NOT! These actions are prohibited. These actions should not be performed at any time or in any circumstances. Performing a prohibited action can cause personal injury and/or equipment damage. On the product, this icon is represented as a white symbol with a black circle and black slash.

1. INTENDED USE

Wheelchair Models:

Aspire Metro - Attendant Propelled

Aspire Metro - Attendant Propelled Wheelchairs are specifically designed for individuals who, due to a wide variety of reasons, have limited mobility or are unable to walk. This product should be used as a tool to assist with mobility or walking difficulties.

Aspire Metro - Attendant Propelled Wheelchairs are able to be propelled by an attendant with the push handles. This wheelchair has been designed to be used indoors and outdoors on dry, hard and levelled terrain.

Aspire Metro and MetroX - Self Propelled

Aspire Metro and MetroX - Self Propelled Wheelchairs are specifically designed for individuals who, due to a wide variety of reasons, have limited mobility or are unable to walk. This product should be used as a tool to assist with mobility or walking difficulties.

Aspire Metro and MetroX - Self Propelled Wheelchairs are able to be propelled by a user with the self-propelling wheels or by an attendant with the push handles. This wheelchair has been designed to be used indoors and outdoors on dry, hard and levelled terrain.



This wheelchair is intended to bear the weight of an occupant through its wheels during propulsion and when stationary. It is NOT designed to be carried with an occupant in the seat and doing so may cause serious injury or death.

2. PRODUCT DESCRIPTION

Aspire Metro - Attendant Propelled





The Aspire Metro - Attendant Propelled model is a four wheeled wheelchair with a cross folding frame. The product is made from aluminium, so it is light and easy to store or transport. This wheelchair offers great manoeuvrability, stability and it's legrests are height adjustable for a customised fit. It is equipped with a padded mesh seat and backrest, push handles, manoeuvrable 14 inch rear wheels, flip-up legrests and armrests.

Aspire Metro and MetroX - Self Propelled

The Aspire Metro and MetroX - Self Propelled models are four wheeled wheelchairs with a cross folding frame. The product is made from aluminium, so it is light and easy to store or transport. These wheelchairs offer great manoeuvrability, stability and their legrests are height adjustable for a customised fit. They are equipped with a padded mesh seat and backrest, push handles, manoeuvrable 20 inch rear wheels, flip-up legrests and armrests.

3. WARNINGS

MAXIMUM WEIGHT CAPACITY - 100KG - FOR ALL ASPIRE METRO MODELS.



-  **DO NOT** exceed maximum user weight. This weight limit includes any accessories, shopping or other personal items that may be carried on the chair.
-  **DO NOT** stand on the foot plates as the wheelchair may tip forwards. The foot plates are not designed to be a weight bearing surface.
-  **WARNING** Pay attention to your fingers when folding or opening the wheelchair and when self-propelling the chair with hands in close proximity to wheel spokes.
-  **ALWAYS** use push rims to bring the wheelchair to a stop. Do not use the handbrakes to stop a moving wheelchair.
-  **DO NOT** use the wheelchair on escalators, even if accompanied by an attendant.

4. PRODUCT SPECIFICATIONS

Aspire Metro Wheelchair Models:

MODEL	OVERALL LENGTH (mm)	OVERALL WIDTH (mm)	OVERALL HEIGHT (mm)	SEAT DEPTH (mm)	SEAT WIDTH (mm)	SEAT HEIGHT (mm)	BACKREST HEIGHT (mm)	ARMREST HEIGHT (mm)	SAFE WORKING LOAD (SWL) (KG)	REAR WHEEL (inch)	FOLDED DIMENSIONS D x W x H (mm)
Metro Attendant Propelled MWS442350	930	600	910	400	450	450	470	220	100	14"	680 x 220 x 670
Metro Self Propelled MWS442360	930	650	910	400	450	450	470	220	100	20"	750 x 310 x 670
MetroX Self Propelled MWS442370	930	650	910	400	450	450	470	220	100	20"	750 x 310 x 670

Chair Weights:

	Metro Attendant Propelled
	Metro Self Propelled
	MetroX Self Propelled

Product Finishes:

MODEL	FRAME COLOUR	UPHOLSTERY COLOUR
Metro Attendant Propelled MWS442350	Midnight Blue	Grey/Black
Metro Self Propelled MWS442360	Midnight Blue	Grey/Black
MetroX Self Propelled MWS442370	Metallic Orange	Grey/Black

5. LIST OF COMPONENTS



Metro
Attendant Propelled

1	14" Rear Wheels
2	6" Front Wheels
3	Wheel fork
4	Handbrakes
5	Height Adjustable Legrests
6	Folding Foot Plates
7	Flip-Up Armrests
8	Padded Seat Upholstery
9	Folding Backrest with Padded Upholstery and Carry Pouch
10	Attendant Hand Grips
11	Frame Cross Bar



Metro
Self Propelled

1	20" Rear Wheels
2	6" Front Wheels
3	Wheel fork
4	Handbrakes
5	Height Adjustable Legrests
6	Folding Foot Plates
7	Flip-Up Armrests
8	Padded Seat Upholstery
9	Folding Backrest with Padded Upholstery and Carry Pouch
10	Attendant Handbrakes with Lock
11	Attendant Hand Grips
12	Frame Cross Bar
13	Push Rims



MetroX
Self Propelled

1	20" Rear Wheels
2	6" Front Wheels
3	Wheel fork
4	Handbrakes
5	Height Adjustable Legrests
6	Folding Foot Plates
7	Flip-Up Armrests
8	Padded Seat Upholstery
9	Folding Backrest with Padded Upholstery and Carry Pouch
10	Attendant Handbrakes with Lock
11	Attendant Hand Grips
12	Frame Cross Bar
13	Push Rims

6. ASSEMBLY

Aspire Metro Wheelchairs

BOX CONTAINS:

Wheelchair frame fitted with rear wheels

- i) 14 inch (Metro - Attendant Propelled) **OR**
20 inch (Metro and MetroX - Self Propelled).
- ii) User Manual

**MetroX - Self Propelled model shown in instructional images*

1. Place the wheelchair on levelled ground. Then, push both legrests down and click into place, so that the locking bracket hugs the aluminium tubing.

2. Pushdown on the side rails of the seat until flat.

3. Flip up and click backrest into place.

IMPORTANT: Ensure your fingers are keep clear from the pivoting mechanism.



When opening the carton, ensure it is done in a safe and careful manner. **DO NOT USE** a box cutter or sharp implement as this may damage the product. For WH&S purposes, lay the carton on its side with the top of the carton open and slide the plastic bag out containing the wheelchair.

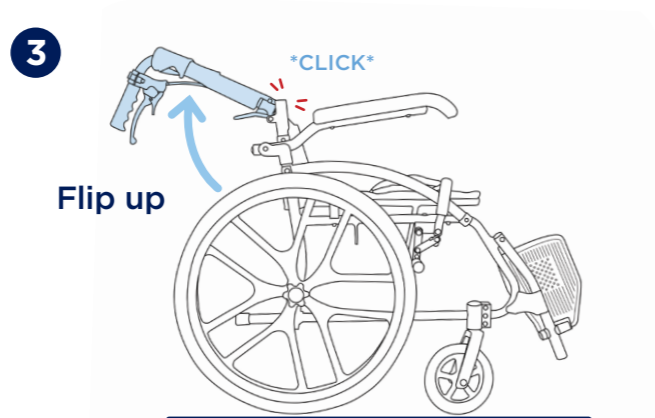
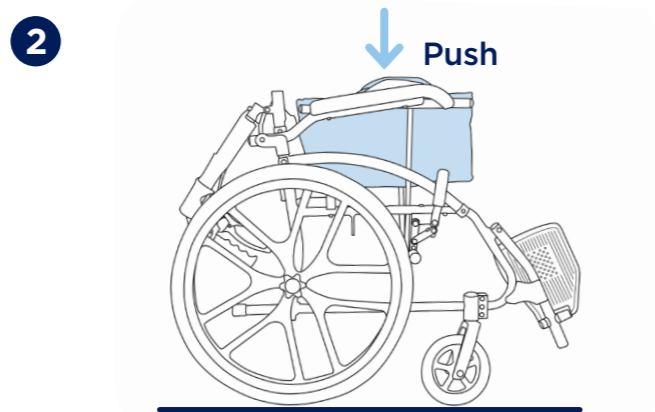
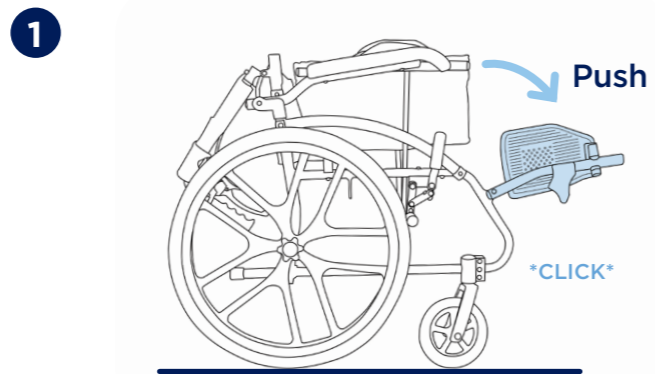

7. PRELIMINARY CHECKS

After assembling the wheelchair, these checks should be completed prior to initial use:

1. Check that the seating surface is locked into place, creating a flat support surface.
2. Check that rear wheels are locked in place.
3. Check that rear brakes engage and disengage.

8. GENERAL OPERATION

General Operation

It is very important that this wheelchair is used under guidance from all warnings or hazards listed in this product user manual. Key safety measures should be taken by both users and attendants when using this wheelchair:

- Avoid quick direction changes
- Ensure your wheelchair is used on surfaces intended for its use
- Control the speed of the wheelchair using the hand rims on the rear wheels (Aspire Metro and MetroX - Self Propelled)
- Ensure an attendant is available to assist at all times (Aspire Metro - Attendant Propelled)
- Ensure an attendant is available to assist where necessary (Aspire Metro and MetroX - Self Propelled)

Lifting the Wheelchair

To fold your chair correctly follow the 'ASSEMBLY' instructions in reverse 3, 2, 1.

Then, use the carry handle on the seating surface to safely lift the wheelchair

 **DO NOT** lift the wheelchair with an occupant in the seat. This lifting guide is for safe handling of the wheelchair only.

 **DO NOT** lift the wheelchair by holding it by the legrests or the armrests! Fold-up the legrests prior to lifting the chair.

Transporting the Wheelchair

To transport this chair in a motor vehicle it is suggested that the backrest, seat and legrests are folded as per the "Lifting the Wheelchair" instructions above. This will help reduce the overall chair size in order to fit into the rear boot or backseat of a standard motor vehicle

 **Aspire Metro Wheelchairs are NOT crash tested and SHOULD NOT** ever be used as a means of transporting a user in a motor vehicle.

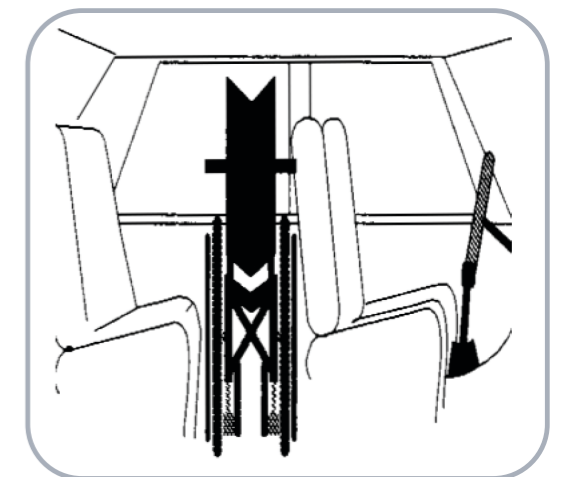
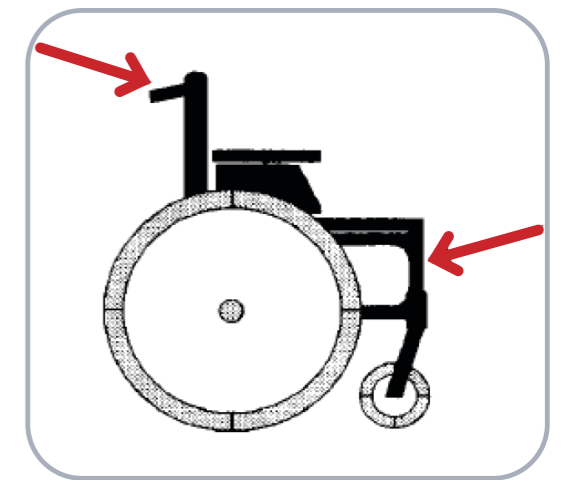

Moving Wheelchair Up a Kerb - With an Attendant

1. Push the wheelchair up to the kerb FEET FIRST.
2. The attendant should push down on the rear foot peg to slightly incline the chair. DO NOT tilt the chair back with the push handles.
3. Once the front wheels are firmly on the ground above the kerb, the rear wheels should be pushed against the kerb to propel the the entire chair to rest above the kerb.

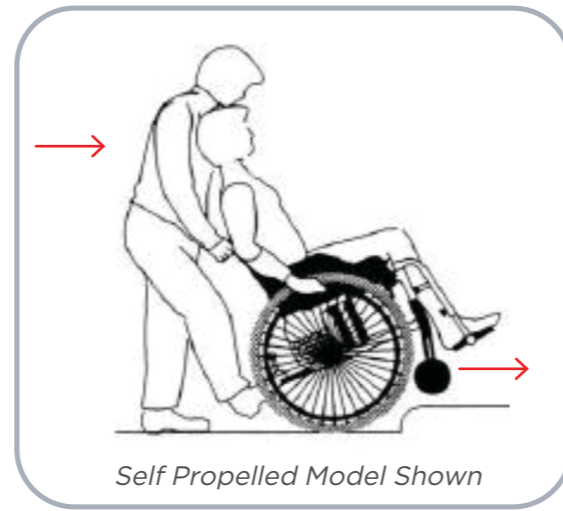

This should only ever be done with an attendant and not performed by a user on their own. It is very important the above steps are followed to prevent injury to both the user and the attendant.

Moving Wheelchair Down a Kerb - With an Attendant

1. Reverse the wheelchair up to the kerb FEET LAST.
2. The attendant should check for cars or obstructions prior to commencing the descent.
3. The attendant should slowly lower the rear wheels down to the road surface, ensuring not to tip the chair.
4. Once the rear wheels are firmly on the road surface, the front wheels should be slowly lowered onto the road surface.

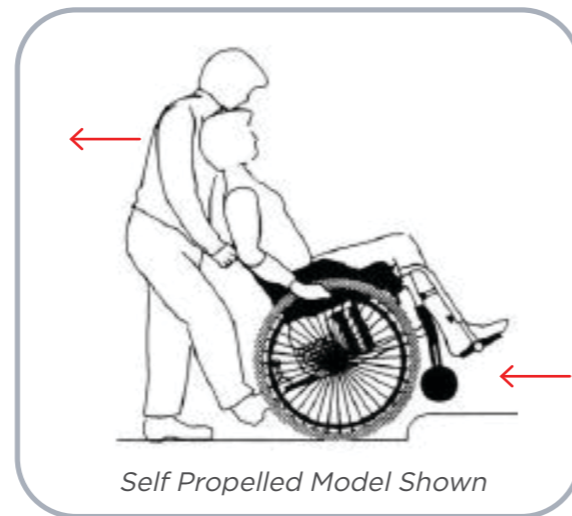

This should only ever be done with an attendant and not performed by a user on their own. It is very important the above steps are followed to prevent injury to both the user and the attendant.

Adjusting Legrest Height

Using a 5mm Allen key loosen the bolt and remove the centre pin. Nominate the preferred height by raising or lowering footplate. To secure, align the centre pin with the chosen hole and tighten.

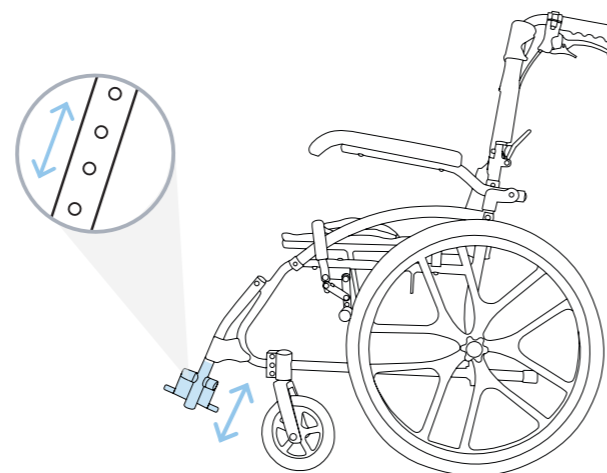

To Adjust the Height:
Loosen.
Raise/Lower.
Tighten.

Using the Wheelchair Brakes

Aspire Metro Wheelchairs have locking brakes to ensure no movement occurs when the wheelchair is in a stationary position.



Brakes should always be locked when leaving a user unattended in the wheelchair.

HANDBRAKES

Lock / Unlock

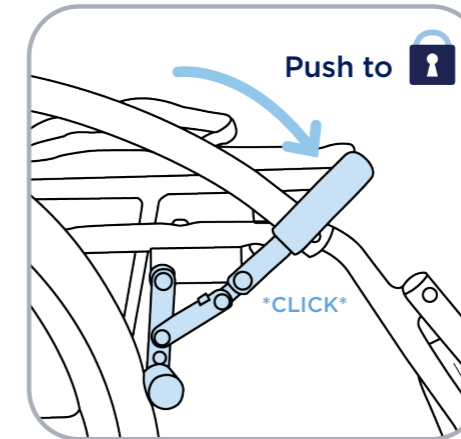

LOCK: To engage brakes, push forward on the brake lever until firmly locked in place.

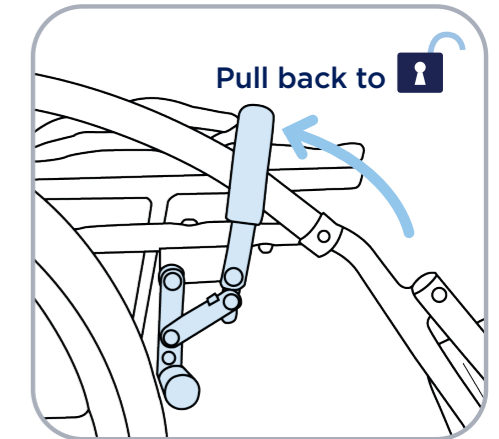

UNLOCK: To disengage brakes, pull back on the brake lever until unlocked.

ATTENDANT HANDBRAKES

Activating Brakes

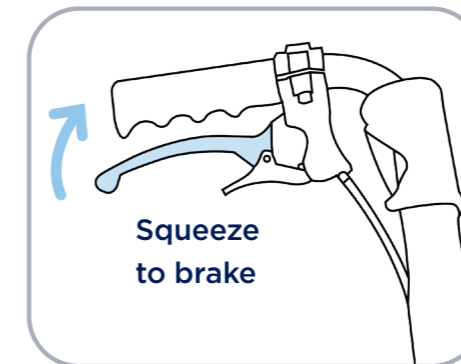

BRAKE: To engage brakes, squeeze the handbrake in an upwards direction.



RELEASE BRAKE: To disengage brakes, release the handbrake.

Lock / Unlock



LOCK: To engage brakes, squeeze the handbrake in an upwards direction. Press down on the switch until it clicks, this will lock the brakes.

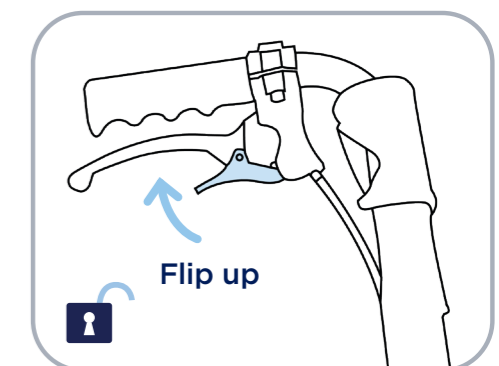

UNLOCK: To disengage brakes, flip the switch upwards.

9. TROUBLESHOOTING

Wheelchair is steering/pulling to one side	• Make sure the rear wheel axle pins have been inserted correctly.
	• Make sure the end user is able to evenly distribute his/her weight on the wheelchair.
	• Make sure one push rim has not been mounted more tightly than the other.
Wheelchair is moving slowly	• Ensure rear wheels axle pins have been inserted correctly.
	• Remove any hair or dirt from castor and rear wheel axles.
	• Make sure there is not too much weight applied to the castors, otherwise adjust the centre of gravity.
	• Ensure user clothing is not interfering with movement of the rear wheels.
	• Ensure both brakes are disengaged.
Wheelchair does not turn smoothly	• Make sure the front fork bolts are not over tightened which can restrict front castor wheel rotation.
	• Remove any hair or dirt from castor axles.
	• Ensure both brakes are disengaged.
Brakes are not working properly	• Check distance between tyres and brake foot is sufficient such that the requisite amount of force can be applied to the tyre surface to stop it moving when the brake is in the engaged position.
Wheelchair cannot be opened or folded easily	• Clean the crossbar under the seat and apply some grease.
	• Check that nothing has become lodged under the seat or in and around the cross bar mechanism.
	• Check foot plates are folded up.

Correct adjustment of the wheelchair is essential for the successful and safe use of this product.

Should assistance be required, contact the Aidacare Service Department on 1300 133 120.

10. CARE & MAINTENANCE

Maintenance Schedule

Weekly	Periodically	Yearly	Serviceable Components
<ul style="list-style-type: none"> • Check brakes are functioning properly 	<ul style="list-style-type: none"> • Check for signs of wear on front castors • Check for signs of wear on rear tyres 	Service to be completed by authorised Aspire service agent	<ul style="list-style-type: none"> • Wheels & Tyres • Forks • Axles • Armrest receivers • Seat sling • Footrest mounts • Footplates • Armrest Pads

Care for Your Chair

- The seat and backrest upholstery can be removed by loosening the screws and wiping with a wet sponge and a mild detergent. All other components can be cleaned with a damp cloth.
- Check tyre condition at least twice per month.
- Check that rear wheel spokes are not loose. Loose wheel spokes can reduce the strength of the rims and must be safely adjusted by a qualified technician.
- Always keep rear wheel axles clean and free from dirt and hair build up.
- Should push rims become scratched these should be de-burred or replaced to avoid damage to skin (not necessary for Aspire Metro - Attendant Propelled model).
- Brakes should be checked regularly.

Should you have any doubts about the correct functioning of the wheelchair or of any of its components, please contact AIDACARE on 1300 133 120 or your local Aspire distributor.

The tool kit provided will allow basic adjustments to the wheelchair, for further information on repairs and service contact AIDACARE on 1300 133 120.

11. WARRANTY



**Aspire Metro Wheelchairs come with a 1 year warranty.
Please keep purchase invoice as proof of warranty commencement.**

Aidacare is bound by Australian Consumer Law in respect to 'Warranty against Defects' on this product. A copy of the Aidacare 'Warranty against Defects' statement is available off the Home page of our website at www.aidacare.com.au. Any contact in regard to warranty matters should be made to Aidacare Customer Service staff on 1300 133 120 or where support will be provided.

Aidacare does not warrant against excessive or incorrect use, modification or any situation that could not be deemed as fair wear and tear. Tyres, tubes and castor wheels are not covered under the 1 year warranty as these are considered consumable items. These consumable items carry a 12 month warranty against manufacturer defects only, NOT wear and tear from reasonable use.

The warranty on this product is a back to base warranty and does not cover any freight costs pertaining to the return of any items under warranty. Aidacare acknowledges and conforms to all ACCC guidelines around consumer rights. For further information contact Aidacare 1300 133 120.

Aidacare will not guarantee the safety and the correct functioning of the wheelchair in the case that any of the original components have been changed or modified and or replaced with non-original Aidacare approved parts. If any faults are detected upon receiving the wheelchair please phone Aidacare to arrange a replacement. Any faults that are detected during normal use should be reported to Aidacare immediately to determine if warranty conditions apply and organise repair and/or replacement as applicable.

12. COMPLIANCE

This Wheelchair range is manufactured in ISO compliant production facilities in P.R China to strict quality control standards.

As part of Australian Standards compliance, safety stickers are located on the frame of this wheelchair. Please ensure that you familiarise yourself with these prior to use.

This product complies with Australian Standard AS/NZS 3695.1:2011. As the importer of this product, Aidacare maintains records of all testing reports and compliance certificates. All testing was Certified by Novitatech Children's Services in South Australia.

Novitatech is an independent NATA accredited laboratory and is widely acknowledged as the leading provider of safety testing services for wheelchairs and mobility products in Australia.

13. SERVICE MAINTENANCE & CUSTOMISATION

FOR ALL ENQUIRIES, PLEASE CALL 1300 133 120

When sending the chair back for warranty, service or repair work please include all components such as leg rests, armrests and seat cushion. Please ensure wheelchair is clearly marked with owner's name and contact details.

To organise pickup by Aidacare, please call 1300 133 120, standard pickup and delivery charges apply.

SPARE PARTS

Aidacare stock replacement parts for the Aspire wheelchair range. All replacement of parts should be completed by Aidacare or authorised Aspire service technician. The term parts includes but is not limited to: tyres, brakes, armrests, footrests and upholstery.

A complete parts list is available upon request.

CUSTOMISATION AND MODIFICATION

All wheelchair customisation, modifications and or alterations made to this product are considered as "custom" changes. These may cause the product to no longer satisfy Australian Standards and should be considered prior to commencement.

For customisation or modification work, contact AIDACARE on 1300 133 120. Our team of qualified Rehab Engineers are available to assist if required.

AIDACARE PTY LTD

Building 3A, 1 Moorebank Avenue,
Moorebank NSW Australia 2170
1300 133 120 | www.aspirecare.com.au